

Article number: 25075264002

Description: ICME Single-phase motor MD80 B2 0,75KW  
2 - 2800 rpm 1x230 Volt 50Hz B5 with starting & running capacitor

## Measures

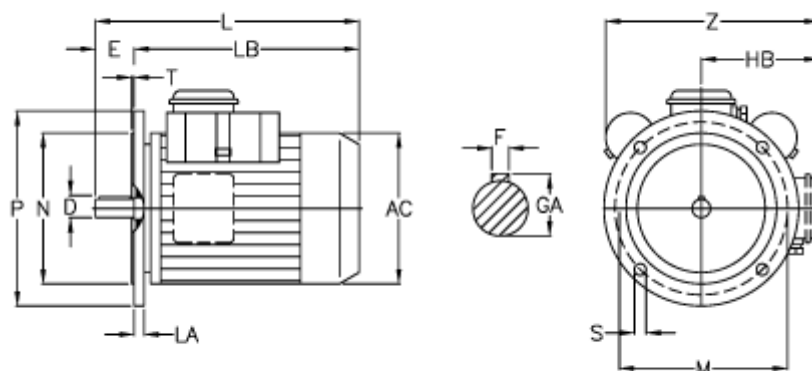

AC = 156	LB = 265
D = 19	M = 165
E = 40	N = 130
F = 6	P = 200
GA = 21.5	S = 11.5
HB = 122	T = 3.5
L = 305	Z = 230
LA = 12.0	